

TOREX SEMICONDUCTOR | 6616

Sponsored Research
February 28, 2023



TOREX Group well-positioned for the downturn GX initiatives in focus on climate change policies gathering steam

SUMMARY

- ▶ The semiconductor cycle has entered the final reset stage coming into 2023, where YoY comps against a high base in 1H 2022 turn negative. The FY2023/3 OP forecast of ¥5.0bn is on track to top the FY2026/3 MTP OP target of ¥4.0bn, and management decided on brisk 1H results to deploy these upfront profit gains to move ahead of schedule and establish a sustainable production system to support expected high demand going forward, announcing new capex of roughly ¥1.7bn to finance a portion of capacity expansion at an overseas foundry where it concluded a long-term production consignment agreement. The Company plans to announce a revised MTP in May along with full-term results.
- ▶ In its 5-Year MTP 2021 – 2025 [FY22/3 – FY26/3], the TOREX Group is promoting its GX Green Transformation initiatives toward realization of a net zero carbon-neutral society through: ① development of highly efficient, energy-saving power management IC products, ② resource conservation with package miniaturization and space-saving design, and ③ reduced power loss with low ON resistance (the smaller the value, the lower the power loss) through development and sales promotion of next-generation silicon carbide (SiC) and gallium oxide (β -Ga₂O₃) power devices. The current P/E of 7.9x is trading on a 32% discount, and even factoring in a reset in FY24/3, any weakness likely presents a new entry opportunity in SIR's view.

Simultaneous growth drivers: 5G, IoT devices, EV ramp-up, connected cars, DX/AI...

Life is analog.
Torex power management ICs:
Supporting electronic devices in every field

Consumer Electronics
Automotive
Industrial
Medical & Healthcare
Computers & Communications

3Q Follow-up



Focus Points:

Power management IC specialist with attractive growth profile from new applications driven by 5G, IoT-connected devices and the electrification of cars.

Key Indicators

Share price (2/27)	2,465
YH (23/2/10)	2,843
YL (22/5/10)	2,444
10YH (21/11/30)	3,960
10YL (14/5/20)	725.8
Shrs out. (mn shrs)	11.554
Mkt cap (¥ bn)	28.481
EV (¥ bn)	24.91
Equity ratio	65.4%
23.3 P/E (CE)	7.7x
23.3 EV/EBITDA (CE)	3.9x
22.3 ROE (act)	14.9%
22.9 P/B (act)	1.29x
23.3 DY (CE)	2.3%

6M weekly share price

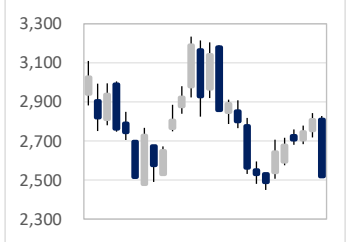

Source: SPEEDA price data

Chris Schreiber CFA

Company Specialist

research@sessapartners.co.jp



This report was prepared by Sessa Partners on behalf of TOREX SEMICONDUCTOR, LTD. Please refer to the legal disclaimer at the end for details.



TOREX (parent)

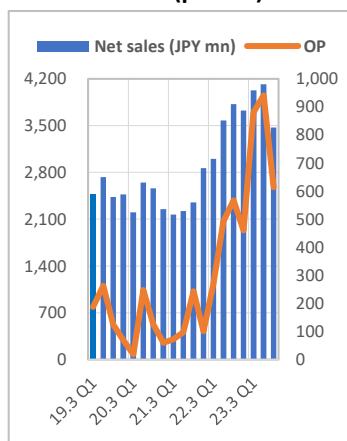

Phenitec contribution

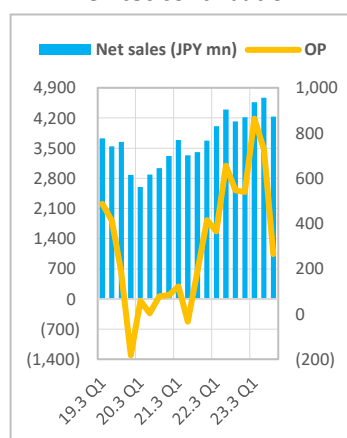

Source: compiled by SIR from IR quarterly results briefing materials.

1H 2023 will mark YoY comps down

New entry opportunity approaching on any weakness

RESULTS SUMMARY

- ▶ TOREX SEMICONDUCTOR announced consolidated financial results for 3Q FY23/3 at 15:30 on Tuesday 2/14. Headline numbers for the cumulative nine months were net sales +9.4% YoY, OP +48.1% YoY and profit attributable to owners of parent +45.4% YoY. However, as can be seen from the table below, 3Q-only (Oct-Dec) net sales were -3.0% YoY, OP was -21.1% YoY, and OPM dipped from 2Q 19.0% → 3Q 11.4%. The slowdown in the overall electronics market became more pronounced in the 3Q, with a significant decrease in demand for PCs, as well as growing concerns about a global recession in the wake of high inflation and monetary tightening, triggering inventory consolidation.
- ▶ TOREX parent 3Q-only net sales declined -9.2% YoY due to the pullback in demand. Phenitec experienced a sharp rise in cost of sales due to soaring electricity costs (see lower graph on P3) and increased repair and depreciation expenses due to increased investment, etc. Phenitec contribution 3Q-only OP declined -51.6% YoY. As explained in our 2Q Follow-up report, the issue of high electricity costs will persist going into 1H FY24/3, and depreciation is set to rise.
- ▶ The key takeaway from 3Q results is that **the cycle has entered the final stage reset period where YoY comps turn negative** (see upper and middle graphs on P3). However, the share price already peaked at 3,960 on 2021/11/30 as a leading indicator, nearly 15 months ago, and considering the outlook for a recovery from 2H 2023, SIR believes any selloff on figures declining YoY in coming months presents an ideal entry opportunity.

TOREX SEMICONDUCTOR FY23/3 3Q Consolidated Financial Results Summary

JPY mn, %	FY18/3	FY19/3	FY20/3	FY21/3	FY22/3	FY23/3	FY23/3	FY23/3	FY23/3	FY23/3
	act	act	act	act	act	init CE*	1Q act	2Q act	3Q act	4Q CE
Net sales	23,997	23,897	21,501	23,713	30,864	33,000	8,594	8,791	7,699	7,917
YoY	11.3	(0.4)	(10.0)	10.3	30.2	6.9	22.5	10.3	(3.0)	(0.3)
• Phenitec contrib.	13,828	13,792	11,837	14,107	16,740	—	4,565	4,672	4,230	—
YoY	21.5	(0.3)	(14.2)	19.2	18.7	—	13.8	6.3	2.7	—
• Torex parent	10,168	10,104	9,663	9,605	14,124	—	4,028	4,119	3,469	—
YoY	(0.1)	(0.6)	(4.4)	(0.6)	47.0	—	34.2	15.2	(9.2)	—
Gross profit	7,177	6,494	5,452	5,959	9,474	—	3,175	3,152	2,399	—
GPM	29.9%	27.2%	25.4%	25.1%	30.7%	—	36.9%	35.9%	31.2%	—
SG&A	4,964	4,943	4,774	4,750	5,577	—	1,432	1,485	1,520	—
Ratio to sales	20.7%	20.7%	22.2%	20.0%	18.1%	—	16.7%	16.9%	19.7%	—
Operating profit	2,212	1,551	678	1,209	3,898	5,000	1,743	1,667	879	711
YoY	76.8	(29.9)	(56.3)	78.3	222.3	28.3	174.1	45.3	(21.1)	(29.0)
OPM	9.2%	6.5%	3.2%	5.1%	12.6%	15.2%	20.3%	19.0%	11.4%	9.0%
• Phenitec contrib.	1,579	904	225	693	2,108	—	863	726	265	—
YoY	176.5	(42.7)	(75.1)	208.0	204.2	—	135.8	10.8	(51.6)	—
OPM	11.4%	6.6%	1.9%	4.9%	12.6%	—	18.9%	15.5%	6.3%	—
• Torex parent	633	646	453	516	1,789	—	880	941	614	—
YoY	(6.9)	2.1	(29.9)	13.9	246.7	—	225.9	91.3	8.3	—
OPM	6.2%	6.4%	4.7%	5.4%	12.7%	—	21.8%	22.8%	17.7%	—
Yen-dollar rate	¥110.8	¥110.7	¥109.1	¥106.2	¥112.9	¥135.0	¥129.0	¥138.0	¥139.2	¥133.8
Capex	1,149	3,323	1,497	1,179	1,916	5,334	517	391	2,586	1,840
Depreciation	934	1,085	1,312	1,208	1,311	1,904	353	385	416	750

Source: compiled by SIR from TANSBIN financial statements and IR results briefing materials.

*Note: initial CE for the yen-dollar rate of ¥120.0 and capex 3,646mn yen revised on 1H results to the green box values.

Business environment and current phase in the cycle: 1H 2023 will mark the reset with YoY comps down

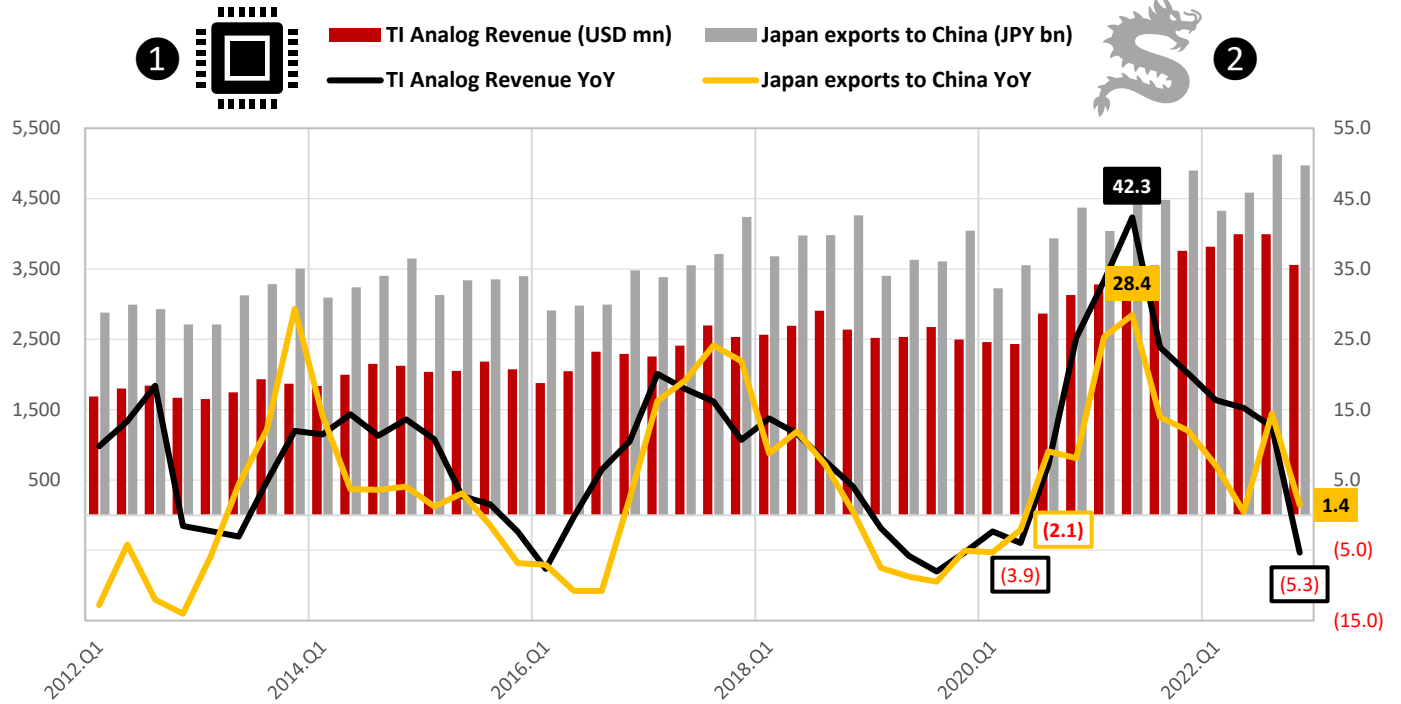

Japan exports to China have been a **reliable proxy** for the general health of the global electronics supply chain, likely a function of Japan's ongoing leadership in critical electronic components and advanced materials.

Small and nimble TOREX Group can outperform (underperform) from time to time

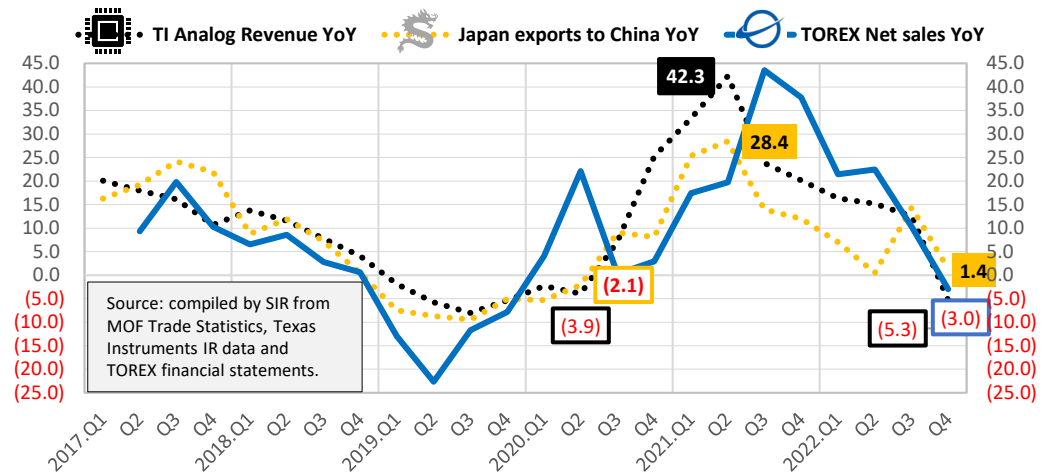

Chugoku region electricity average unit price (¥/kWh): high voltage (for factories etc.)

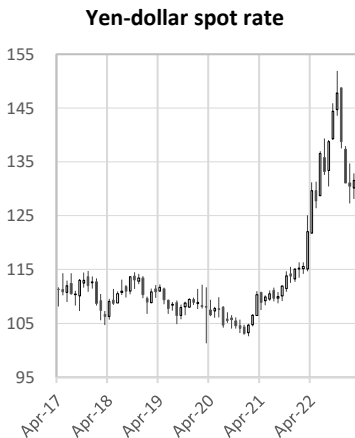
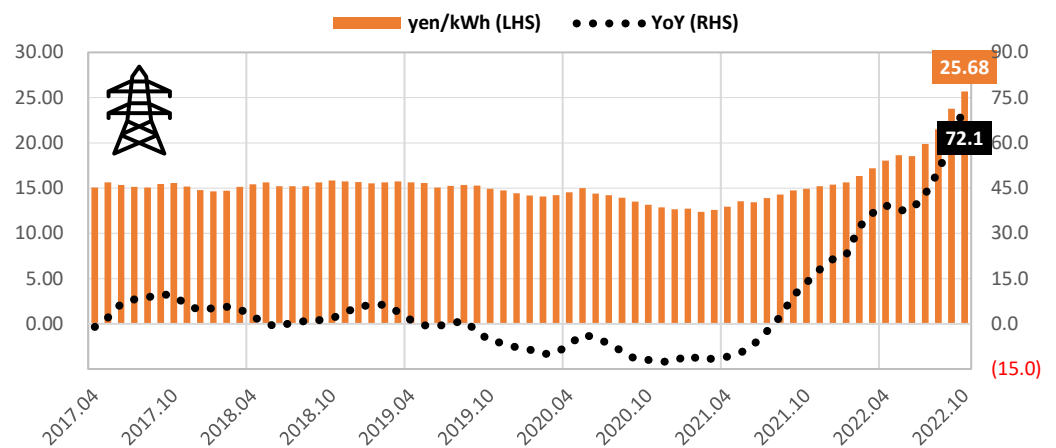

Source: Yahoo! Finance

Source: New Power Net is a membership-based information site operated by the Energy Information Center (EIC).

Torex (parent) Sales Trend by Application and 'Design-in' based* Region with YoY Heat Map

JPY mn, %	1Q 20/3	2Q 20/3	3Q 20/3	4Q 20/3	1Q 21/3	2Q 21/3	3Q 21/3	4Q 21/3	1Q 22/3	2Q 22/3	3Q 22/3	4Q 22/3	1Q 23/3	2Q 23/3	3Q 23/3
by Application															
Torex sales	2,202	2,649	2,563	2,249	2,170	2,220	2,351	2,864	3,002	3,575	3,820	3,727	4,028	4,119	3,469
• Industrial equipt.	784	912	933	834	872	763	805	1,064	1,033	1,238	1,262	1,352	1,610	1,632	1,281
• Automotive equipt.	350	615	457	327	241	249	352	398	400	423	464	466	510	593	462
• Medical equipt.	25	21	29	43	73	44	43	66	49	59	65	49	90	95	97
• Wearable equipt.	53	66	54	47	50	100	100	112	86	107	102	116	113	137	96
• Other	990	1,035	1,090	998	934	1,064	1,051	1,224	1,434	1,748	1,927	1,744	1,705	1,662	1,533
YoY															
Torex sales	(11.1)	(2.9)	5.4	(8.9)	(1.5)	(16.2)	(8.3)	27.3	38.3	61.0	62.5	30.1	34.2	15.2	(9.2)
• Industrial equipt.	(18.8)	(14.2)	(1.3)	(12.5)	11.2	(16.3)	(13.7)	27.6	18.5	62.3	56.8	27.1	55.9	31.8	1.5
• Automotive equipt.	(8.1)	60.2	26.2	(19.9)	(31.1)	(59.5)	(23.0)	21.7	66.0	69.9	31.8	17.1	27.5	40.2	(0.4)
• Medical equipt.	(30.6)	(19.2)	11.5	16.2	192.0	109.5	48.3	53.5	(32.9)	34.1	51.2	(25.8)	83.7	61.0	49.2
• Wearable equipt.	(25.4)	(10.8)	45.9	(16.1)	(5.7)	51.5	85.2	138.3	72.0	7.0	2.0	3.6	31.4	28.0	(5.9)
• Other	(3.1)	(12.3)	2.6	(1.7)	(5.7)	2.8	(3.6)	22.6	53.5	64.3	83.3	42.5	18.9	(4.9)	(20.4)
by Region															
Torex D-in* sales	2,202	2,649	2,563	2,249	2,170	2,220	2,351	2,864	3,002	3,575	3,820	3,727	4,028	4,119	3,469
• Japan	950	1,090	1,104	1,043	896	895	958	1,129	1,160	1,379	1,433	1,594	1,437	1,479	1,413
• Asia	724	1,001	980	700	781	849	876	1,105	1,197	1,444	1,469	1,197	1,432	1,465	1,094
• Europe	305	329	268	310	259	242	304	384	383	408	465	542	686	699	615
• North America	223	229	211	196	234	234	213	246	262	344	453	394	473	476	347
YoY															
Torex D-in* sales	(11.1)	(2.9)	5.4	(8.9)	(1.5)	(16.2)	(8.3)	27.3	38.3	61.0	62.5	30.1	34.2	15.2	(9.2)
• Japan	(12.5)	(6.0)	3.2	(4.0)	(5.7)	(17.9)	(13.2)	8.2	29.5	54.1	49.6	41.2	23.9	7.3	(1.4)
• Asia	(8.5)	11.7	19.8	(13.3)	7.9	(15.2)	(10.6)	57.9	53.3	70.1	67.7	8.3	19.6	1.5	(25.5)
• Europe	(11.6)	(18.2)	(11.8)	(18.2)	(15.1)	(26.4)	13.4	23.9	47.9	68.6	53.0	41.1	79.1	71.3	32.3
• North America	(12.2)	(15.2)	(12.1)	(0.5)	4.9	2.2	0.9	25.5	12.0	47.0	112.7	60.2	80.5	38.4	(23.4)

*Note: Torex 'Design-in' based sales = regional sales adj. on orders rec'd basis.

Phenitec Sales Trend by Application and Region with YoY Heat Map**

JPY mn, %	1Q 20/3	2Q 20/3	3Q 20/3	4Q 20/3	1Q 21/3	2Q 21/3	3Q 21/3	4Q 21/3	1Q 22/3	2Q 22/3	3Q 22/3	4Q 22/3	1Q 23/3	2Q 23/3	3Q 23/3
by Application															
Phenitec** sales	2,983	3,251	3,435	3,628	3,982	3,703	3,732	4,077	4,536	4,990	4,729	4,827	5,184	5,241	4,773
• Industrial equipt.	408	412	493	696	911	630	588	653	676	793	756	757	846	912	1,184
• Automotive equipt.	876	921	892	915	838	738	869	942	1,044	1,228	1,090	1,126	1,256	1,230	1,160
• Medical equipt.	70	48	54	116	60	32	34	39	36	38	43	53	30	47	82
• Other	1,629	1,870	1,996	1,901	2,173	2,303	2,241	2,443	2,780	2,931	2,840	2,891	3,052	3,052	2,347
YoY															
Phenitec** sales	(27.9)	(18.2)	(15.7)	11.0	33.5	13.9	8.6	12.4	13.9	34.8	26.7	18.4	14.3	5.0	0.9
• Industrial equipt.	(46.2)	(41.6)	(55.2)	(0.3)	123.3	52.9	19.3	(6.2)	(25.8)	25.9	28.6	15.9	25.1	15.0	56.6
• Automotive equipt.	(3.5)	5.5	(3.4)	6.9	(4.3)	(19.9)	(2.6)	3.0	24.6	66.4	25.4	19.5	20.3	0.2	6.4
• Medical equipt.	(28.6)	(23.8)	(62.8)	38.1	(14.3)	(33.3)	(37.0)	(66.4)	(40.0)	18.8	26.5	35.9	(16.7)	23.7	90.7
• Other	(31.3)	(19.8)	4.7	16.6	33.4	23.2	12.3	28.5	27.9	27.3	26.7	18.3	9.8	4.1	(17.4)
by Region															
Phenitec** sales	2,983	3,251	3,435	3,628	3,982	3,703	3,732	4,077	4,536	4,990	4,729	4,827	5,184	5,241	4,773
• Japan	1,346	1,410	1,427	1,403	1,280	1,277	1,307	1,654	1,983	2,286	1,983	2,096	2,034	1,976	1,852
• Asia	495	661	803	805	914	869	1,088	1,193	1,118	1,084	1,275	1,269	1,568	1,468	904
• Europe	199	224	261	236	268	244	194	183	230	269	222	219	303	350	335
• North America	943	956	944	1,184	1,520	1,313	1,143	1,047	1,205	1,351	1,249	1,243	1,279	1,447	1,682
YoY															
Phenitec** sales	(27.9)	(18.2)	(15.7)	11.0	33.5	13.9	8.6	12.4	13.9	34.8	26.7	18.4	14.3	5.0	0.9
• Japan	(9.0)	3.5	5.2	5.3	(4.9)	(9.4)	(8.4)	17.9	54.9	79.0	51.7	26.7	2.6	(13.6)	(6.6)
• Asia	(51.4)	(38.2)	7.1	72.4	84.6	31.5	35.5	48.2	22.3	24.7	17.2	6.4	40.3	35.4	(29.1)
• Europe	0.5	23.1	27.9	15.1	34.7	8.9	(25.7)	(22.5)	(14.2)	10.2	14.4	19.7	31.7	30.1	50.9
• North America	(34.5)	(29.7)	(46.5)	(6.3)	61.2	37.3	21.1	(11.6)	(20.7)	2.9	9.3	18.7	6.1	7.1	34.7

**Note: Phenitec sales include intra-company transactions with Torex. Classifications subject to change.

TOREX Group Quarterly Trend of Consolidated Net Sales by Entity (JPY million)

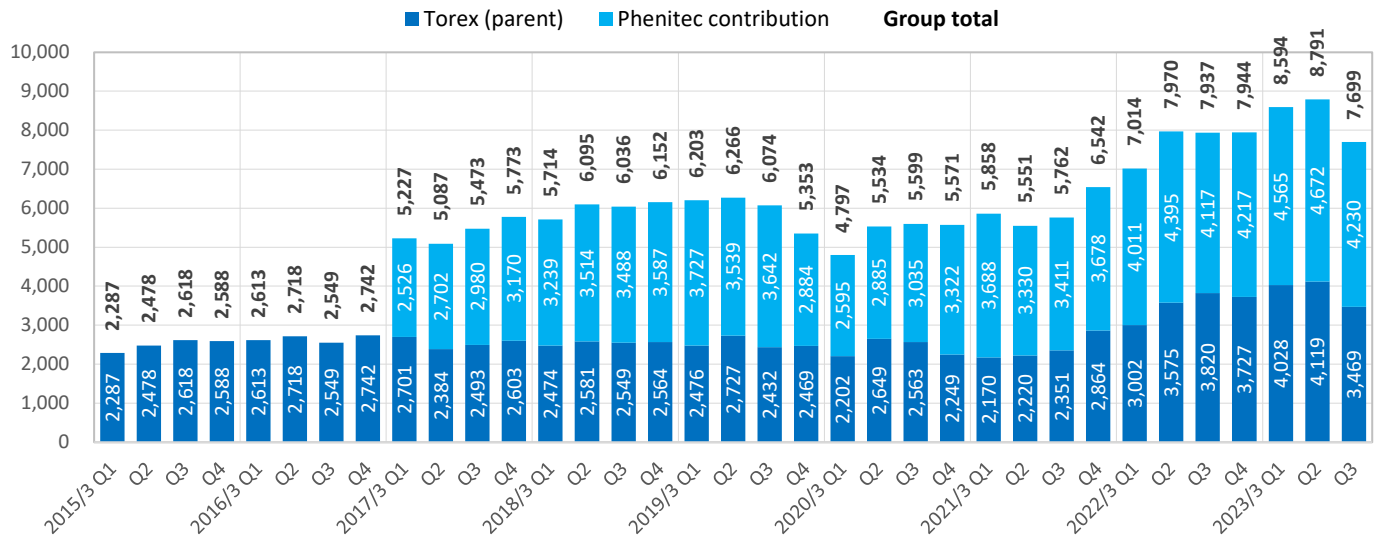

TOREX Group Quarterly Trend of Consolidated Operating Profit by Entity (JPY million)

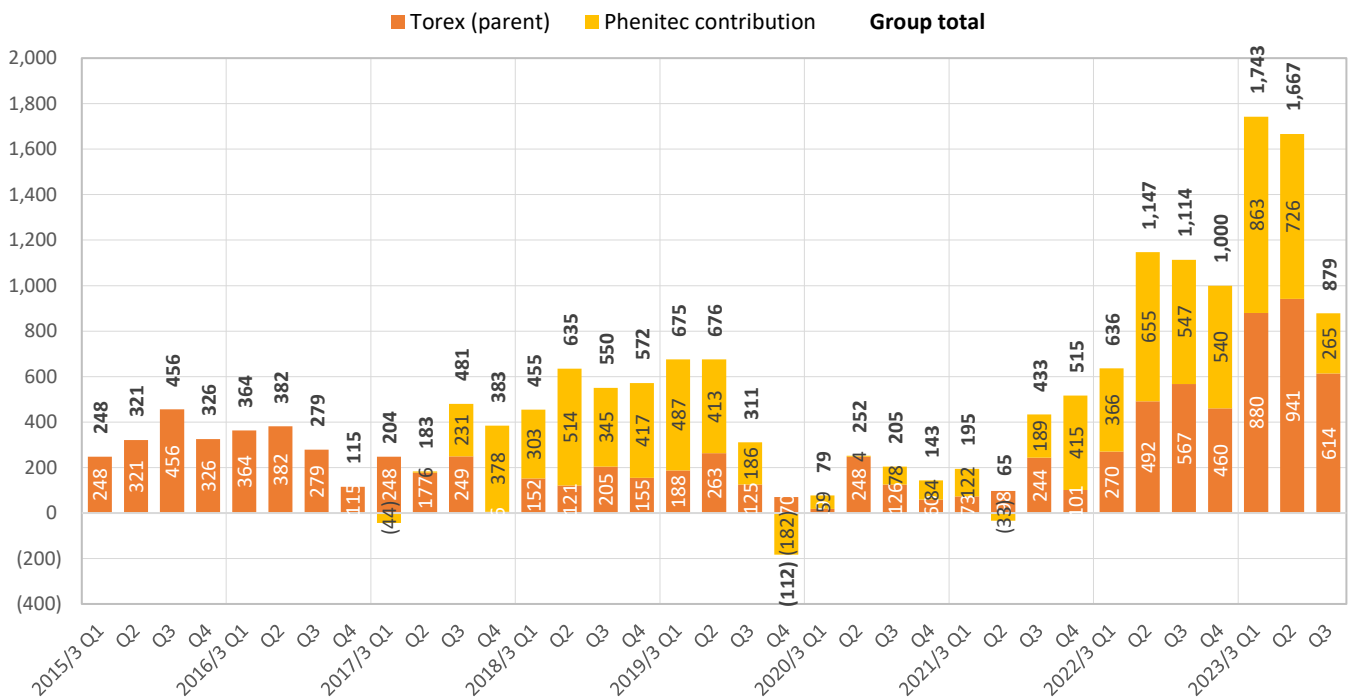

Monthly Trend of the Yen-Dollar Rate





Announced major new capex on likely topping MTP OP target 3 years ahead of schedule

NEW CAPEX SUMMARY

▶ President Koji Shibamiya unveiled major new growth investments at the 1H results briefing. Specifically, for the current term Ending March 31, 2023, the full-term capex forecast was revised up from the initial estimate of ¥3,646mn → ¥5,334mn (+46% upward revision, +178% YoY). President Shibamiya acknowledged that he felt a keen sense of risk to the Group’s sustainability from the impact of global semiconductor supply capacity shortages, including difficulty in expanding capacity, price hike demands for critical raw materials such as wafers, and risk of production suspension. The additional investment is intended to establish a structure for stable, long-term production of the Groups’ high-performance products targeting automotive and industrial equipment applications with medium-to-high breakdown voltage, large current, and high operating temperatures, etc., through strengthening collaboration with an overseas foundry to address risk exposure of fabless TOREX. He noted that the FY2023/3 consolidated OP target of ¥5,000mn is on course to exceed the FY2026/3 (final year of the MTP) consolidated OP target of ¥4,000mn 3 years ahead of schedule, and that management has decided to deploy these upfront profit gains to move ahead of schedule and establish a sustainable production system to support expected high growth for the Group’s products from multiple structural growth drivers on P10.

Annex for new clean room



▶ Specific measures to increase TOREX production capacity and establish a sustainable production structure to meet future demand growth include: 1) leverage the Phenitec Kagoshima fab as a core fab, and 2) strengthen the tie-up with an overseas foundry as an outside fab, aiming to boost TOREX 2025 production capacity by +50% relative to the level of 2021. In order to achieve this, TOREX concluded a long-term production consignment contract with an overseas foundry: 1) secured 8-inch production capacity necessary for the development of new high-performance products, including medium-to-high breakdown voltage products, and 2) allocated a portion of Torex funds to finance capacity expansion at the foundry (¥1.7bn @ USD135 to purchase mfg. equipment), and the line is scheduled to start mass production in FY2025/3 (depreciation to start in FY2024/3). In addition, TOREX will invest in expansion of existing lines, as well as building a new clean room, making Kagoshima a core fab for TOREX. A revised MTP will be announced together with full-term FY2023/3 results.

The elevated level of strategic capex this term and next term points toward depreciation set to rise in FY24/3 and FY25/3.

FY2023/3 Consolidated capex forecast hiked by roughly ¥1.7bn

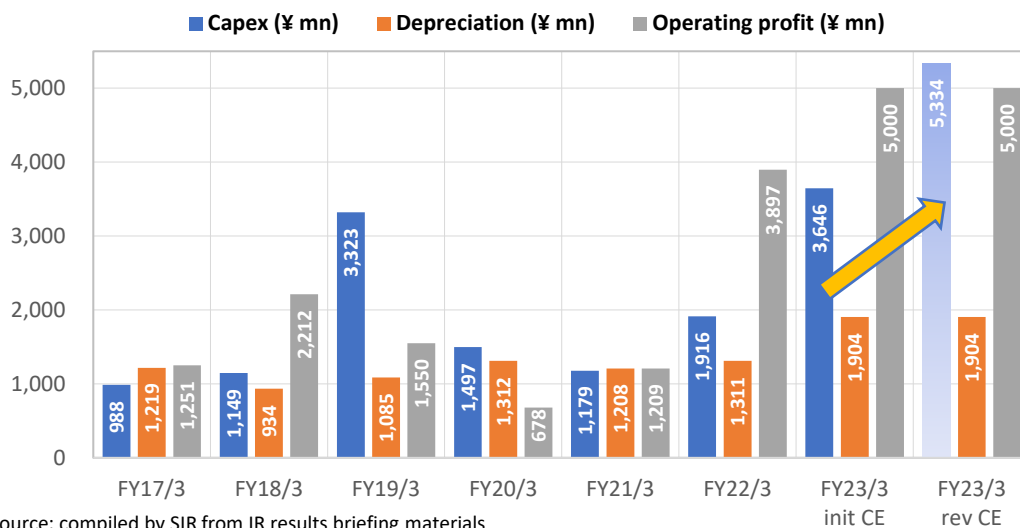

Source: compiled by SIR from IR results briefing materials

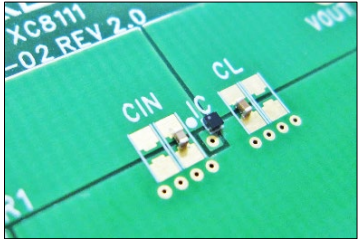

Super Monozukuri Parts Grand Award 2022

Torex XC8110/XC8111 series "ideal diodes" awarded for excellence

▶ Torex was recognized for excellence at "The Super Monozukuri Parts Grand Award 2022" held by Monozukuri Nippon Conference and The Daily Industrial News. Conventional diodes which allow current to flow in one direction, have problems such as large losses on forward voltage V_F , heat generation, battery life, and individual variations. The XC8110/XC8111 series are load switch ICs that reproduce ideal diodes, and are equipped with functions including chip enable (CE), over current limit, overheat protection and ON/OFF function, the ideal diode technology which is not found in conventional diodes. Compared to Schottky barrier diodes, which are generally used to prevent backflow, the voltage corresponding to V_F is lowered to about 1/20 and achieves low loss. This ultra low power switching IC with ideal diode characteristics not only improves battery life and safety, but also achieves significant size reduction.

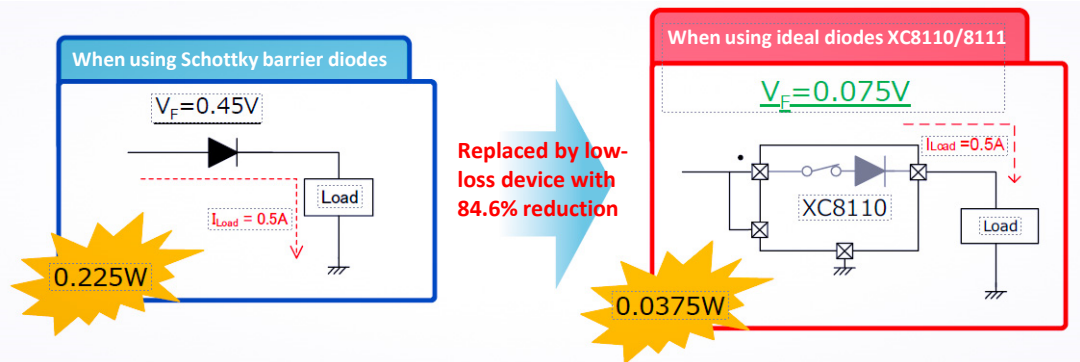

New progress in SiC next-gen power device development during 3Q FY23/3



Participated in the "Tsukuba Power Electronics Constellation (TPEC)" initiated by National Institute of Advanced Industrial Science and Technology (AIST) toward further device development, focusing mainly on R&D for MOSFETs.

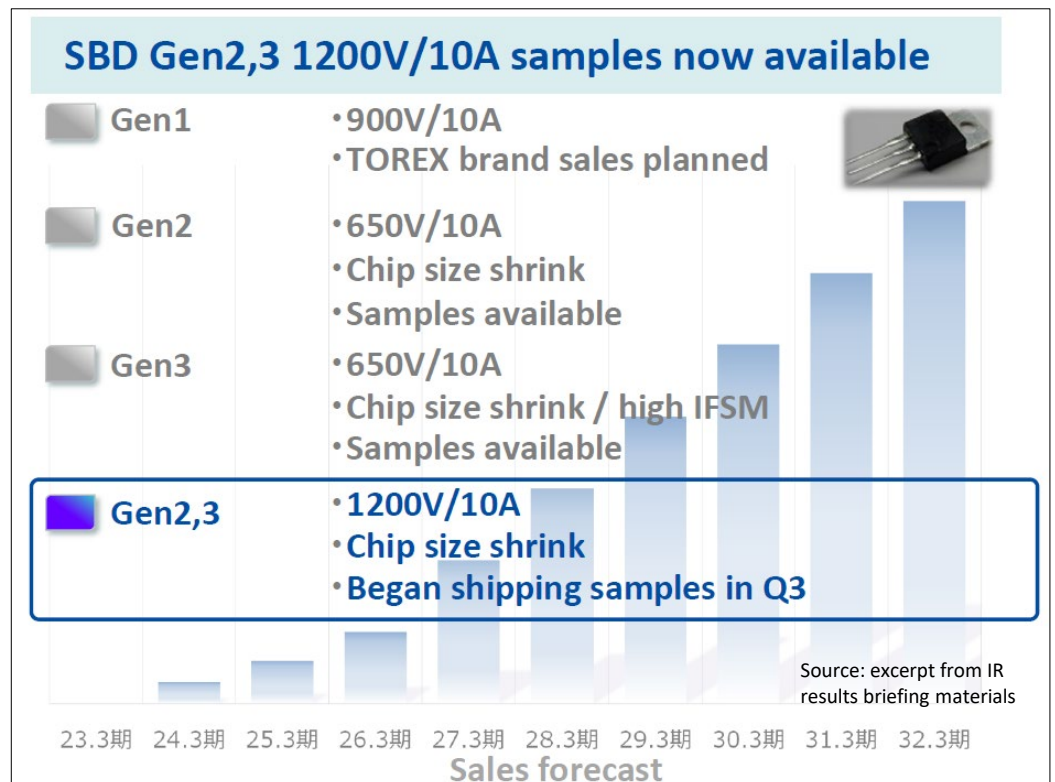



Performance and Valuations:
SESSA Smart Charts

- ✓ The P/E of 7.9x is 32% below the historical avg. EV/EBITDA of 3.8x is 11% below the historical avg. These appear quite attractive considering medium-term growth potential.
- ✓ Structural growth drivers for TOREX include 5G rollout/IoT device proliferation/DX shift, EV/hybrid ramp, and demand for next-gen power devices to combat climate change.



Analyst's view

3-Year Weekly Share Price, 13W/26W/52W MA, Volume and Valuations Trend

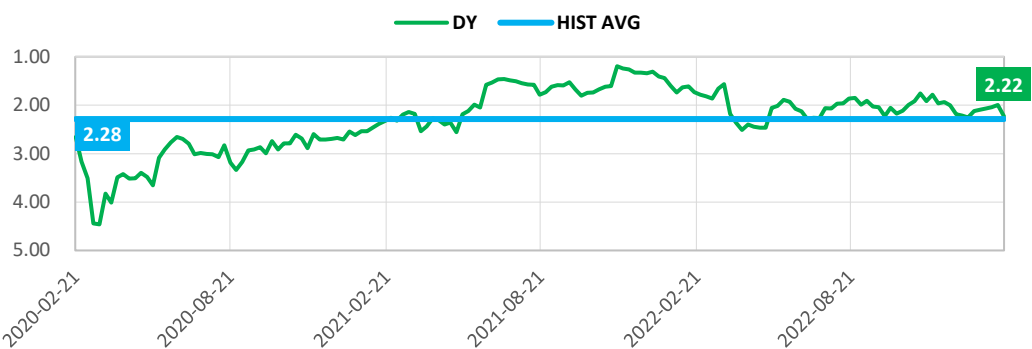
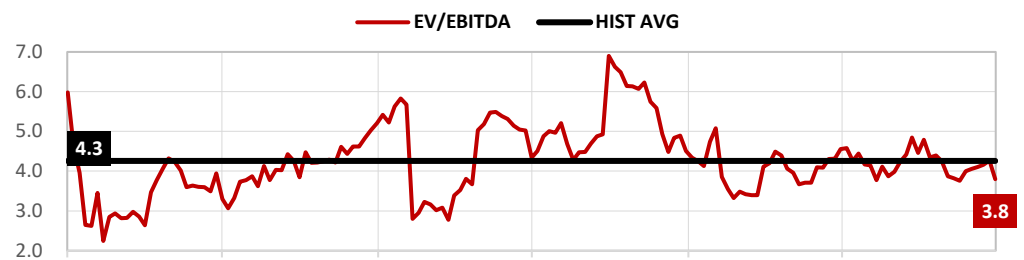
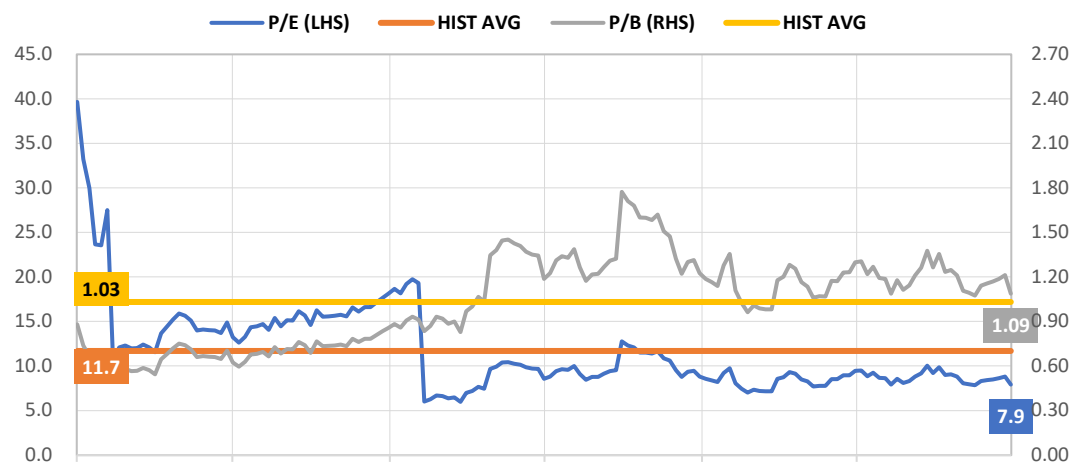

Source: compiled by SIR from SPEEDA historical earnings and price data. Valuations calculated based on CE.

The PHLX Semiconductor Sector is a Philadelphia Stock Exchange capitalization-weighted index composed of the 30 largest US companies primarily involved in the design, distribution, manufacture, and sale of semiconductors, created from December 1, 1993.

PHLX Semiconductor Sector Index (NASDAQ: SOX) 3-Year Weekly Price Chart

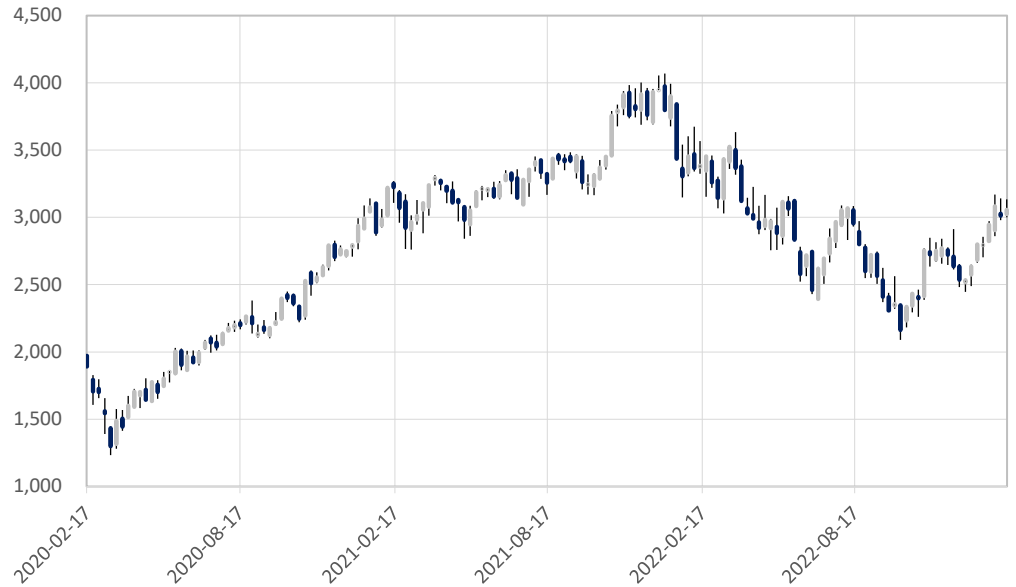

3-Year Weekly Relative Performance of TOREX SEMICONDUCTOR and Texas Instruments

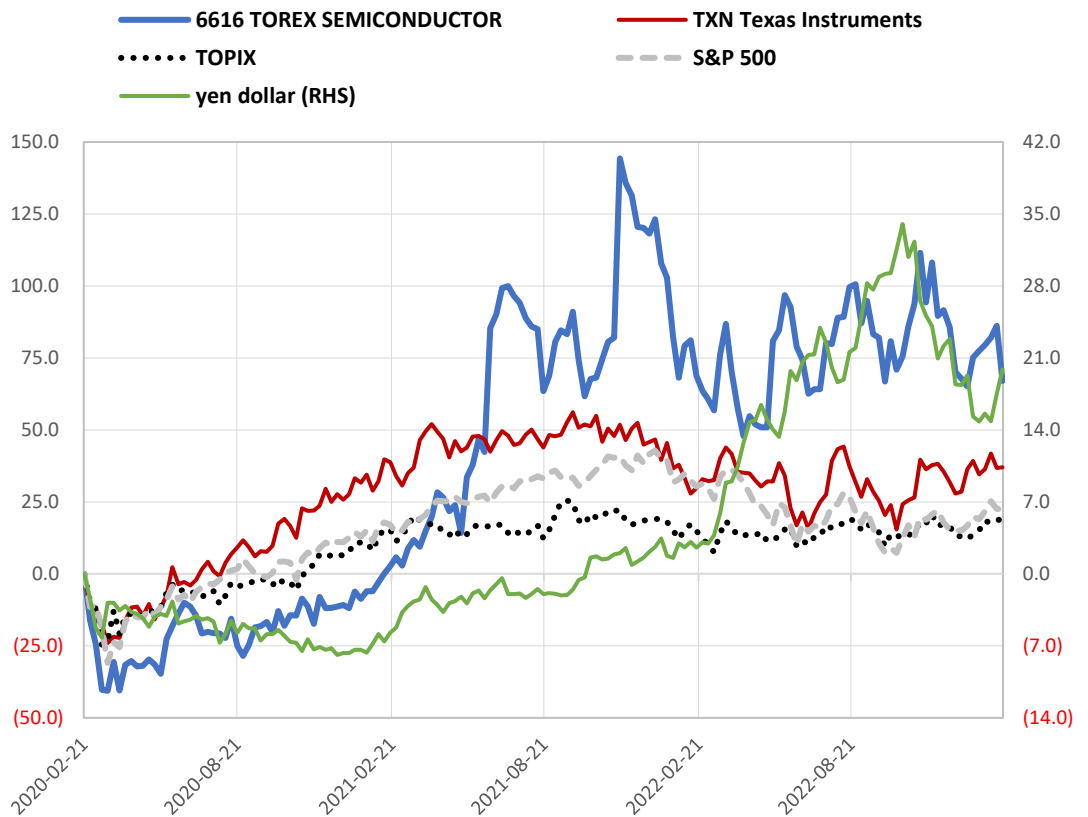

It is worth noting that the world leader in design and manufacture of analog devices, Texas Instruments, is outperforming the S&P 500, likely reflecting the more favorable outlook than the overall semiconductor market in 2023 (see market outlook on PP 10-12).

Source: compiled by SIR from Yahoo Finance (upper) and SPEEDA (lower) price data. Prices not adjusted for currency (in LC).

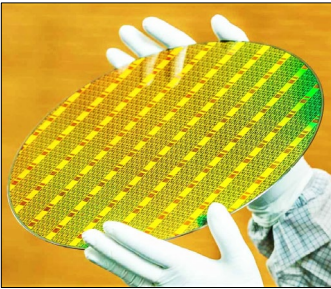

Analog and discrete still up YoY in 2023

WSTS FALL FORECAST SUMMARY

▶ World Semiconductor Trade Statistics (WSTS), the leading provider of global monthly shipment data on semiconductors based on member manufacturers, announced its revised FALL 2022 forecast on November 29, shown in the graphs below and the master table on the next page. The forecast for CY2022 was revised down by -10.3% from the May forecast of \$646bn (+16.3% YoY) → \$580bn (+4.4% YoY), and the forecast for CY2023 was revised down by -18.1% from the May forecast of \$680bn (+5.1% YoY) → \$557bn (-4.1% YoY). The largest factor was the downward revision for memory ICs.

▶ Against the backdrop of general economic slowdown in the wake of global monetary tightening to combat inflation, the sharp 2H production adjustment in high-end smartphones (Samsung, Apple etc.) due to the replacement cycle being pushed out negatively affects demand for memory ICs.

WSTS Fall 2022 Forecast Summary: revised down to 2022 +4.4%, 2023 -4.1%

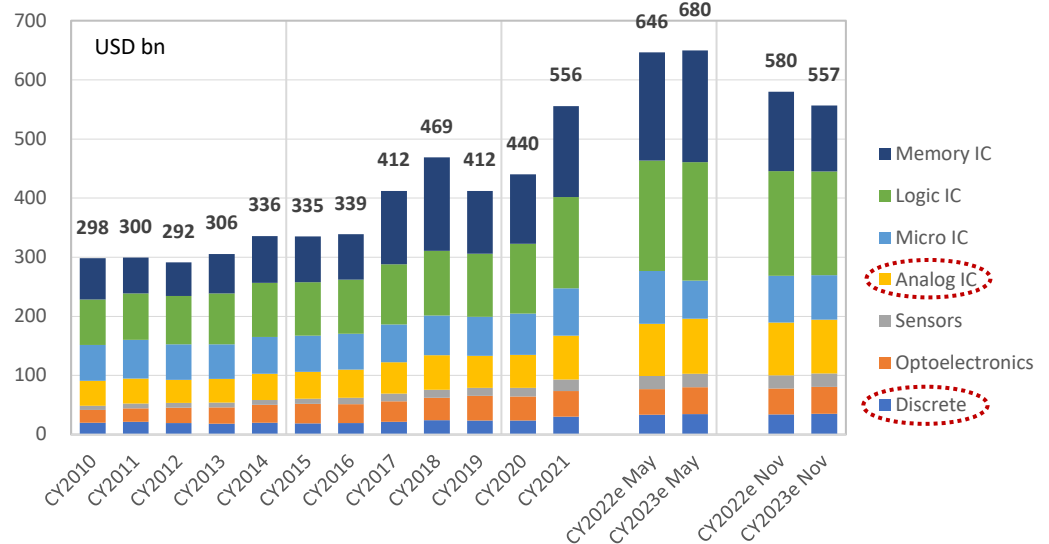

Major factor for the revision is Memory ICs; Analog ICs and Discrete are still up YoY

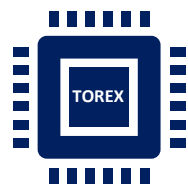
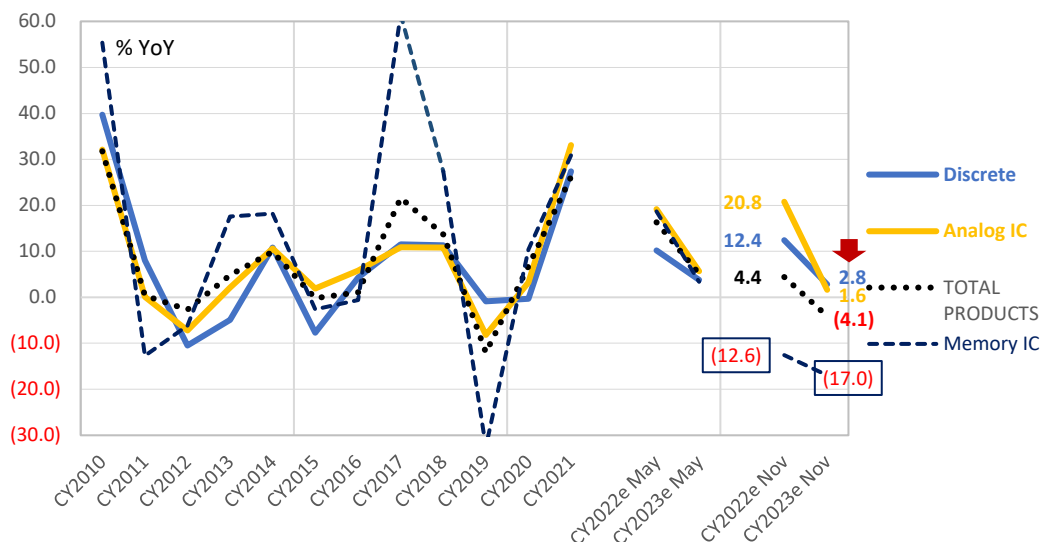

Power management ICs by TOREX the parent are included in analog ICs, and Phenitec's foundry business handles many discrete semiconductors. The key takeaway from the revised forecast for 2023 is that both categories are still up YoY. SIR believes the TOREX Group is well-positioned for the cyclical downturn.

Source: compiled by SIR from World Semiconductor Trade Statistics (WSTS) press release archive.



World Semiconductor Trade Statistics (WSTS) Semiconductor Market Forecast – November 2022

USD million	CY2010	CY2011	CY2012	CY2013	CY2014	CY2015	CY2016	CY2017	CY2018	CY2019	CY2020	CY2021	CY2022	CY2023	CY2022	CY2023
% YoY	act.	act.	act.	act.	act.	act.	act.	act.	act.	act.	act.	act.	May est.	May est.	Nov est.	Novest.
Americas	53,675	55,197	54,359	61,496	69,324	68,738	65,537	88,494	102,997	78,619	95,366	121,481	148,969	155,525	142,138	143,278
Europe	38,054	37,391	33,163	34,883	37,459	34,258	32,707	38,311	42,957	39,816	37,520	47,757	57,669	60,610	53,774	54,006
Japan	46,561	42,903	41,056	34,795	34,830	31,102	32,292	36,595	39,961	35,993	36,471	43,687	49,200	51,554	48,064	48,280
Asia Pacific	160,025	164,030	162,985	174,410	194,230	201,070	208,395	248,821	282,863	257,879	271,032	342,967	390,618	411,961	336,151	311,005
TOTAL WORLD	298,315	299,521	291,562	305,584	335,843	335,168	338,931	412,221	468,778	412,307	440,389	555,893	646,456	679,650	580,126	556,568
Americas	39.3	2.8	(1.5)	13.1	12.7	(0.8)	(4.7)	35.0	16.4	(23.7)	21.3	27.4	22.6	4.4	17.0	0.8
Europe	27.4	(1.7)	(11.3)	5.2	7.4	(8.5)	(4.5)	17.1	12.1	(7.3)	(5.8)	27.3	20.8	5.1	12.6	0.4
Japan	21.6	(7.9)	(4.3)	(15.2)	0.1	(10.7)	3.8	13.3	9.2	(9.9)	1.3	19.8	12.6	4.8	10.0	0.4
Asia Pacific	33.8	(2.5)	(0.6)	7.0	11.4	3.5	3.6	19.4	13.7	(8.8)	5.1	26.5	13.9	5.5	(2.0)	(7.5)
TOTAL WORLD	31.8	0.4	(2.7)	4.8	9.9	(0.2)	1.1	21.6	13.7	(12.0)	6.8	26.2	16.3	5.1	4.4	(4.1)
Discrete	19,802	21,387	19,138	18,201	20,170	18,612	19,418	21,651	24,102	23,881	23,804	30,337	33,444	34,708	34,098	35,060
Optoelectronics	21,702	23,092	26,175	27,571	29,868	33,256	31,994	34,813	38,032	41,561	40,397	43,404	43,534	45,166	43,777	45,381
Sensors	6,903	7,970	8,009	8,036	8,502	8,816	10,821	12,571	13,356	13,511	14,962	19,149	22,159	22,959	22,262	23,086
Integrated Circuits	249,909	247,073	238,240	251,776	277,302	274,484	276,698	343,186	393,288	333,354	361,226	463,002	547,319	576,817	479,988	453,041
● Analog IC	42,285	42,338	39,303	40,117	44,365	45,228	47,848	53,070	58,785	53,939	55,658	74,105	88,324	93,318	89,554	90,952
● Micro IC					2,072	61,298	60,585	63,934	67,233	66,440	69,678	80,221	89,363	64,065	78,790	75,273
● Logic IC					1,633	90,753	91,498	102,209	109,303	106,535	118,408	154,837	186,971	200,539	177,238	175,191
● Memory IC	69,614	60,749	56,995	67,043	79,232	77,205	76,767	123,974	157,967	106,440	117,482	153,838	182,661	188,896	134,407	111,624
TOTAL PRODUCTS	298,315	299,521	291,562	305,584	335,843	335,168	338,931	412,221	468,778	412,307	440,389	555,893	646,456	679,650	580,126	556,568
Discrete	39.7	8.0	(10.5)	(4.9)	10.8	(7.7)	4.3	11.5	11.3	(0.9)	(0.3)	27.4	10.2	3.8	12.4	2.8
Optoelectronics	27.3	6.4	13.4	5.3	8.3	11.3	(3.8)	8.8	9.2	9.3	(2.8)	7.4	0.3	3.7	0.9	3.7
Sensors	45.2	15.5	0.5	0.3	5.8	3.7	22.7	16.2	6.2	1.2	10.7	28.0	15.7	3.6	16.3	3.7
Integrated Circuits	31.3	(1.1)	(3.6)	5.7	10.1	(1.0)	0.8	24.0	14.6	(15.2)	8.4	28.2	18.2	5.4	3.7	(5.6)
● Analog IC	32.1	0.1	(7.2)	2.1	10.6	1.9	5.8	10.9	10.8	(8.2)	3.2	33.1	19.2	5.7	20.8	1.6
● Micro IC	25.5	7.5	(7.6)	(2.6)	5.8	(1.2)	(1.2)	5.5	5.2	(1.2)	4.9	15.1	11.4	5.3	(1.8)	(4.5)
● Logic IC	18.7	1.8	3.7	5.2	6.6	(1.0)	0.8	11.7	6.9	(2.5)	11.1	30.8	20.8	7.3	14.5	(1.2)
● Memory IC	55.4	(12.7)	(6.2)	17.6	18.2	(2.6)	(0.6)	61.5	27.4	(32.6)	10.4	30.9	18.7	3.4	(12.6)	(17.0)
TOTAL PRODUCTS	31.8	0.4	(2.7)	4.8	9.9	(0.2)	1.1	21.6	13.7	(12.0)	6.8	26.2	16.3	5.1	4.4	(4.1)
USD/IPY	87.7	79.7	79.7	97.6	105.7	121.1	108.6	112.1	110.4	108.9	106.8	110.0	116.3	116.3	130.6	138.1

Source: compiled by SIR from WSTS Japan Council database provided by JEITA (Japan Electronics and Information Technology Industries Association) and WSTS press release archive.



Simultaneous demand growth drivers include:

-  **DX (RPA/AI, cloud, big data, industry 4.0)**
-  **5G global rollout, IoT connected devices**
-  **EV global model ramp, connected cars, ADAS**

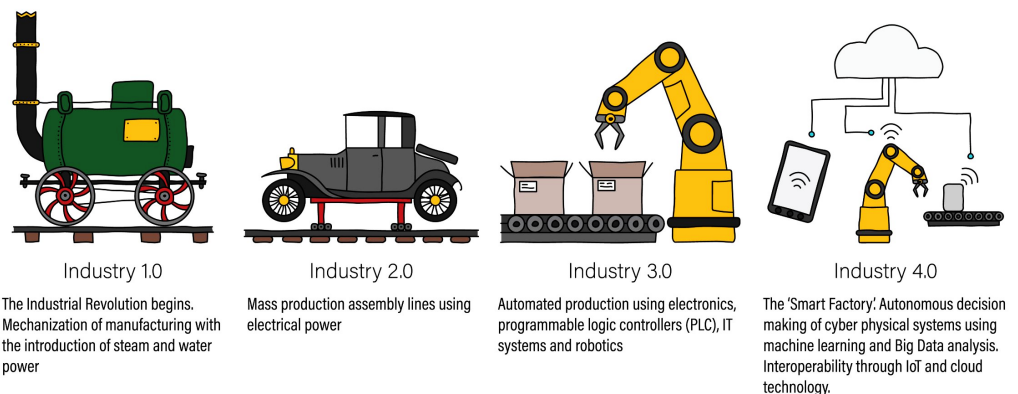

Industry 1.0

The Industrial Revolution begins. Mechanization of manufacturing with the introduction of steam and water power

Industry 2.0

Mass production assembly lines using electrical power

Industry 3.0





Automated production using electronics, programmable logic controllers (PLC), IT systems and robotics

Industry 4.0

The 'Smart Factory'. Autonomous decision making of cyber physical systems using machine learning and Big Data analysis. Interoperability through IoT and cloud technology.

Looking for a recovery from 2H 2023

WSTS GLOBAL SEMICONDUCTOR MARKET TRENDS

-  In CY2021, the global semiconductor market increased significantly by +26.2% YoY to \$556bn, despite the global economy continuing to be impacted by COVID-19, driven by special stay-at-home demand continuing from the previous year, progress in 5G, acceleration of the electrification of cars, and increased investment in data centers, etc.
-  In CY2022, growth in the global semiconductor market is projected to slow significantly to +4.4% to \$580bn, reflecting two years of special stay-at-home demand ending, high inflation affecting demand for personal electronics in particular, and China’s lockdown prolonging the resolution of supply chain disruption. At the same time, demand for automotive and industrial equipment applications remains relatively strong.
-  In CY2023, the global semiconductor market is projected to decline for the first time in four years by -4.1% to \$556bn, and the effects of the market downturn that began in mid-2022 are expected to continue through the 1H of 2023. By products, discrete, optoelectronics, sensors and analog ICs are forecast to continue positive YoY growth with all other categories of ICs projected to decline. The main factor for the overall market contraction is memory ICs are forecast to decline for a second consecutive year by -17.5% (see table on the previous page). By region, Asia Pacific is projected to decline for a second consecutive year by -7.5%.
-  However, a recovery is expected to begin sometime in the 2H of 2023, driven by the progress of 5G rollout and IoT connected devices and the accompanying need for data center capacity expansion, in addition to stable demand for electrification and higher performance of automobiles and investment in renewable energy (structural growth drivers summarized in the Industry 4.0 graphic above).



**TOREX Group 5Y MTP
2021 – 2025
[FY3/22 – FY3/26]**

The new MTP promotes 'GX green transformation' through promoting power-saving circuits, reducing mounting board area and promoting low power-loss devices that suppress heat generation.

Parent Torex will continue to focus on developing high value-added power management ICs, including further share expansion of inductor built-in micro DC/DC converters, products specialized for 5G/IoT, solutions for solid-state and semi solid-state batteries, ultra-compact large-capacity packages, etc.

Initiatives for Phenitex include development of silicon-based power devices and compound semiconductors at Kagoshima, and thorough measures for manufacturing cost reduction, following completion of the Daiichi Plant integration project at Okayama.



2020 Energy Conservation Grand Prize
Product & Business Model Category

Torex Group GX Green Transformation:
 · Promotes power saving ICs and reduced mounting board size
 · Promotes low-loss power devices that dissipate heat generation
 ⇨ Aiming for a carbon-free society.

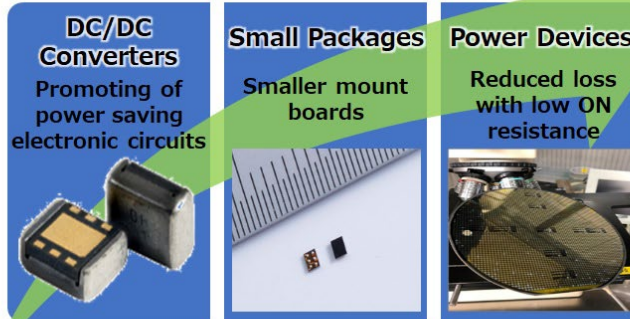

From a company contributing to society with compact, power-saving technologies

Decarbonized Society



Contributing to the realization of a net zero carbon-neutral society through:

① Development of highly efficient, energy-saving power mgt. IC products

The step-down DC/DC converter XC9276 Series was awarded the 2020 Energy Conservation Grand Prize in the Product & Business Model category, by the Energy Conservation Center of Japan. By using the newly developed VSET function for switching the 2-value output voltage, the XC9276 series reduces power consumption by 41.3% and increases battery life by 1.7 times compared with traditional products.

**Reduced Power Consumption
41.3%**

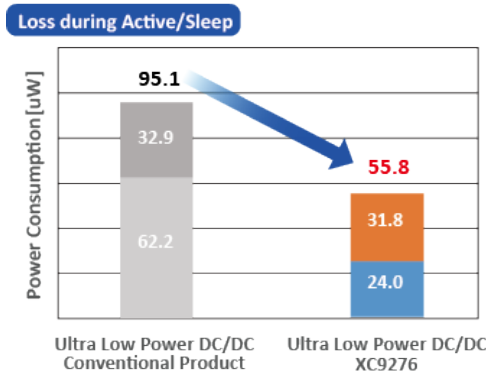

**Battery Life
170%**

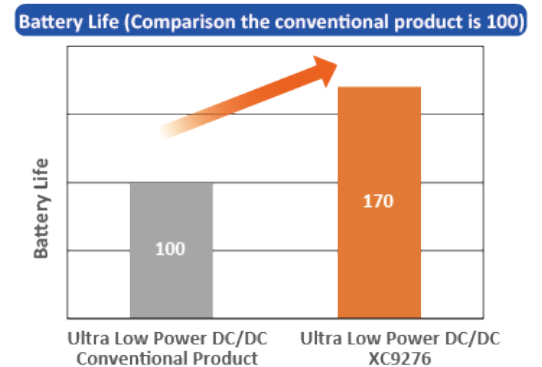

Technology of ultra-low power

Stop the internal circuit of the IC according to the control status of the IC. Realize ultra-low current consumption.

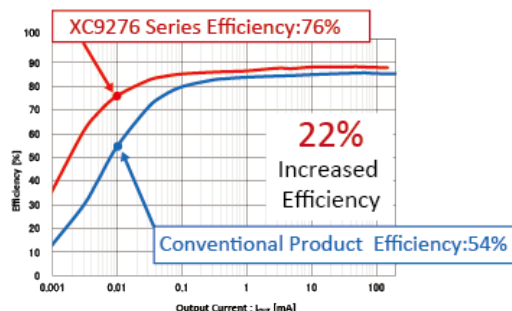

Source: company website.

Technology of switching between two-value output voltage

Only input signal without external parts, Achieves a function that can switch between binary output voltages.

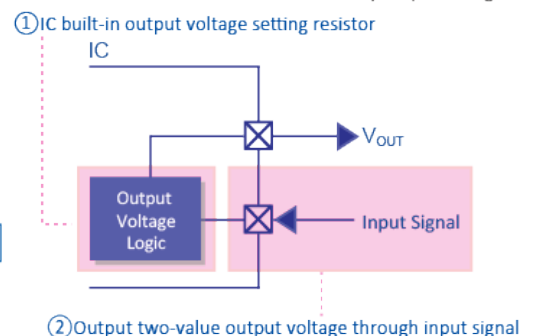

SOT package
(small-outline transistor)

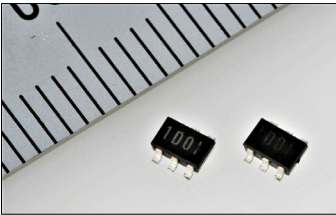

USP package
(ultra-small package)

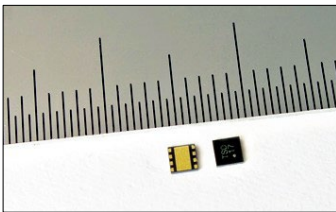

WLP package
(wafer-level package)

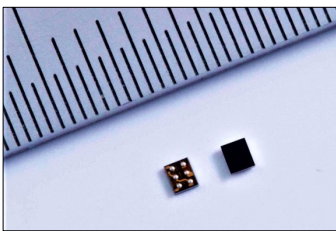

Powerfully small.

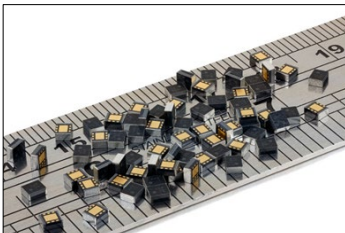

“Micro DC/DC” XCL Series
Ultra small DC/DC converters that integrate a coil and a control IC. Simultaneously achieve **space-saving, high efficiency, low noise, high heat dissipation, and low cost.**

② Resource conservation with PKG miniaturization and space-saving design

The XC9276 series is expected to be deployed in products such as **small IoT devices and wearable devices** that are small and need to be driven for a long time.

Technology of reduce mounting area

The installation area is reduced by reducing the coil inductance value and the IC package area.



High-growth focus product: Inductor Built-in Micro DC/DC converters

The Micro DC/DC XCL Series is ultra small DC/DC converters that integrate a coil and a control IC using Torex's unique technology, which realize devices that **simultaneously achieve space-saving, high efficiency, low noise, high heat dissipation, and low cost.**

Wireless and GPS functions are being added to a wide variety of devices, and radio-frequency interference and noise have become key concerns in electrical circuit design. Torex's Micro DC/DC XCL Series is optimized to achieve a lower noise than with a discrete DC/DC converter configuration. Improving power conversion efficiency is a key point in miniaturizing a power circuit. When semiconductor and electronic components are made smaller, the resistance component increases, and the loss appears as heat generation. The Micro DC/DC XCL Series reduces the loss of efficiency that accompanies miniaturization.

Different package types emphasize the required properties of 1) low EMI noise, 2) small, low-cost, 3) high efficiency/heat dissipation for large current, and 4) high heat dissipation and low noise for high withstand voltages.

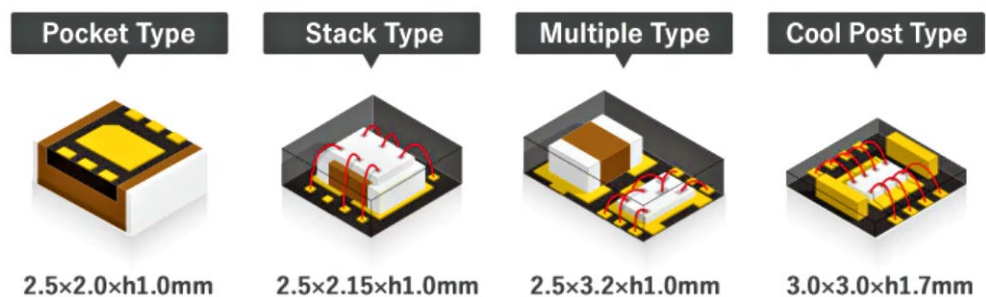

The XCL303/XCL304 series below targets high-speed optical transceivers for 5G applications, and it is the first inductor built-in Micro DC/DC converter product on the market to handle negative output voltage.



Source: company website.

③ Reduced power loss with low ON resistance* through development and sales promotion of next-generation silicon carbide (SiC) and gallium oxide (β -Ga₂O₃) power devices

Phenitex schedule for advancing development of next-generation SiC power devices

Development of SiC devices at 6-inch Kagoshima Plant, start-up of process line, and mass production Development of price-competitive SiC SBDs (Schottky barrier diodes) in progress

→ SiC SBD Gen1 650V/10A Sample shipping now

Participating as an Associate Member of Tsukuba Power Electronics Constellations (TPEC) promoted by the National Institute of Advanced Industrial Science and Technology (AIST) toward further cost reduction and R&D of SiC MOSFETs



2021	2022	2023	2024	2025
------	------	------	------	------

Gen 2 sample shipments by end of FY3/22

Gen1 SBD

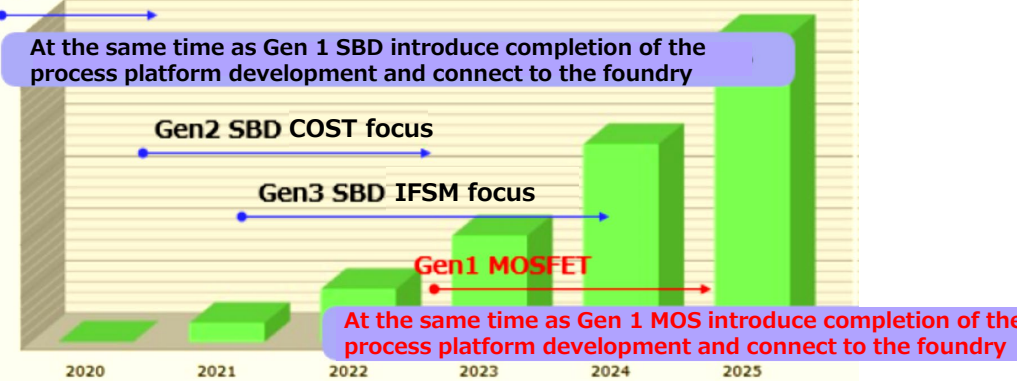

Uses high-concentration substrate

Process simplification

Chip size shrink

- ✓ Low cost
- ✓ High quality

SiC devices produced in-house

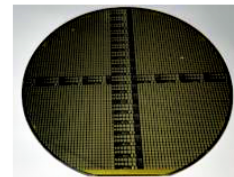

In the future, we will make capital investment according to the progress of development and mass production of SiC-SBD and SiC-FET.

Source: excerpt from 4Q FY3/21 IR results briefing materials, May 24, 2021, updated with 3Q FY3/22 IR results briefing materials, February 14, 2022.

NCT 4-inch beta-gallium oxide β -Ga₂O₃ epitaxial wafer

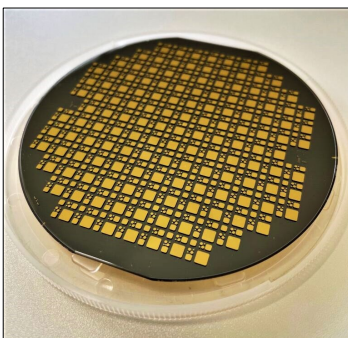

Source: Novel Crystal Technology June 16, 2021 press release.

Torex capital tie-up partner Novel Crystal Technology achieves world's first mass production of 100mm (4-inch) beta-gallium oxide (β -Ga₂O₃) epitaxial wafers, making it possible to mass produce next-generation power devices (June 16, 2021)

Previously Novel Crystal Technology had announced in April 2019 that it succeeded in developing high-quality 50mm (2-inch) beta-gallium oxide (β -Ga₂O₃) epitaxial wafers, and it has been manufacturing them and selling them since then, but they are limited to use for R&D since mass production is not economically viable with 2-inch wafers. Compared with silicon carbide (SiC) and gallium nitride (GaN), beta-gallium oxide (β -Ga₂O₃) has large band gap energy of 4.5eV (electron volts) which translates to lower loss of power, making it ideal for applications such as electric vehicles (EV) and other industrial equipment. In addition, beta-gallium oxide bulk single crystals are grown using the melt growth method, which is 100 times faster than the vapor growth method used for SiC and GaN. Finally, since beta-gallium oxide has a hardness similar to silicon, it can be processed (cutting and polishing) using existing equipment for silicon wafers (reducing the capex burden for customers).

NCT succeeded in demonstrating beta-gallium oxide low-loss Schottky barrier diodes (SBD) with a trench structure in September 2017, and it will continue to build mass production technology for trench-type SBDs on the 100mm line. The company plans to supply 150mm (6-inch) beta-gallium oxide (β -Ga₂O₃) epitaxial wafers in 2023.

*ON Resistance

The resistance value between the Drain and Source of a MOSFET during operation (ON) is called the ON Resistance $R_{DS(on)}$. The smaller the value, the lower the power loss.

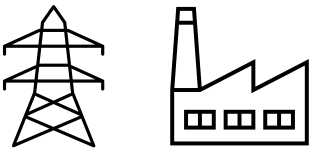

Surging electricity rates to continue into FY24/3

▶ Phenitec’s Head Office Fab and Daiichi Fab are located in Okayama Pref. in the Chugoku Region. Chugoku Electric Power (9504) announced new rate hikes from April 1, 2023. As can be seen from the graph at the bottom, electricity rates are surging. Despite the fact that global oil prices have retreated since peaking last June, and the yen has strengthened from the 151 low in October to 127 this January, electricity rates continue to rise (partly due to the time lag in the fuel surcharge adjustment), and since a new round of rate hikes will take effect from April 1, the negative impact of surging electricity rates is set to continue into FY24/3 for the time being. Revised rates will include FIT purchase cost fluctuations under the revised surcharge adjustment system shown below on the right-hand side. Background cited by Chugoku Electric Power: 1) **dire financial situation**: on top of prolonged nuclear power plant shutdowns and intensifying competition from deregulation, soaring fuel and electricity market prices are set to result in the largest net loss in its history, and the declining equity ratio could hinder ongoing stable supply of electric power due to difficulty in procuring necessary fuel, facilities renewal and repairs, 2) power supply breakdown has changed since FY2008 when rates were last revised, due to an increase in the amount of **electricity purchased under the FIT system and a decrease in nuclear power generation**.

CHG in power supply breakdown

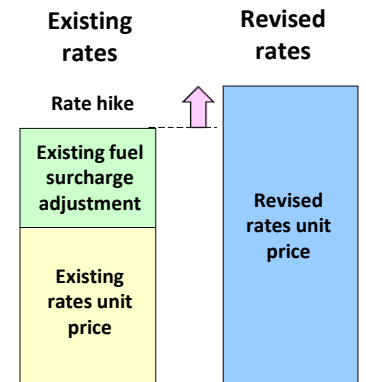
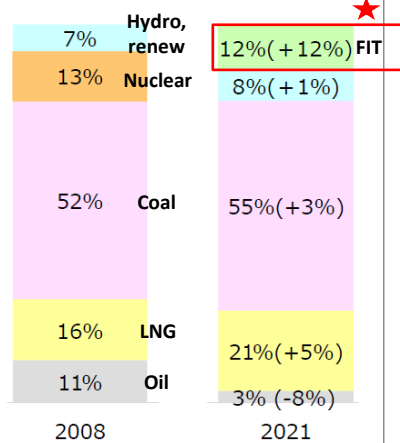

Source: excerpts from Chugoku Electric Power press release (Japanese only)
<https://www.energia.co.jp/assets/2022/press/p22021028-5aUP.pdf>

Current fuel surcharge adj. system

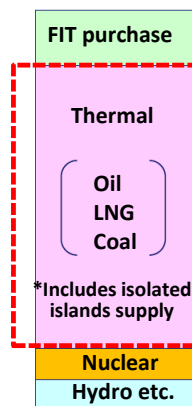

Revised fuel surcharge adj. system

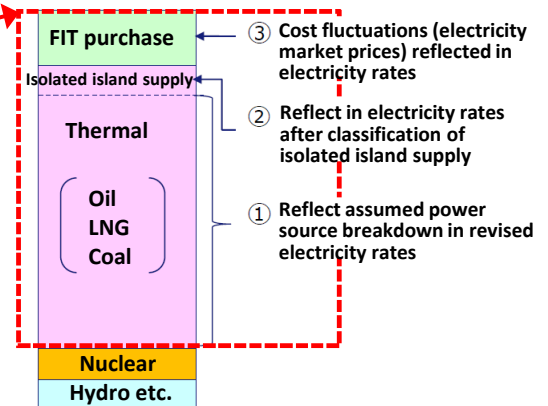

Source: excerpt from Chugoku Electric Power press release October 28, 2022.

The BOJ’s corporate goods price index (CGPI) in Dec-2022 rose +10.2%. Among the main commodity categories, electricity rose +52.3% YoY.

Despite oil prices having come down since peaking in June and the yen reversing from the low of 151 in October to 127 this January, there is a delay in conversion of the sliding fuel surcharge, and **Chugoku Electric Power has already announced rate hikes from April 1, 2023, so the negative impact is set to continue into FY24/3 for the time being.**

BOJ Corporate Goods Price Index: Electricity (20-Year Trend)

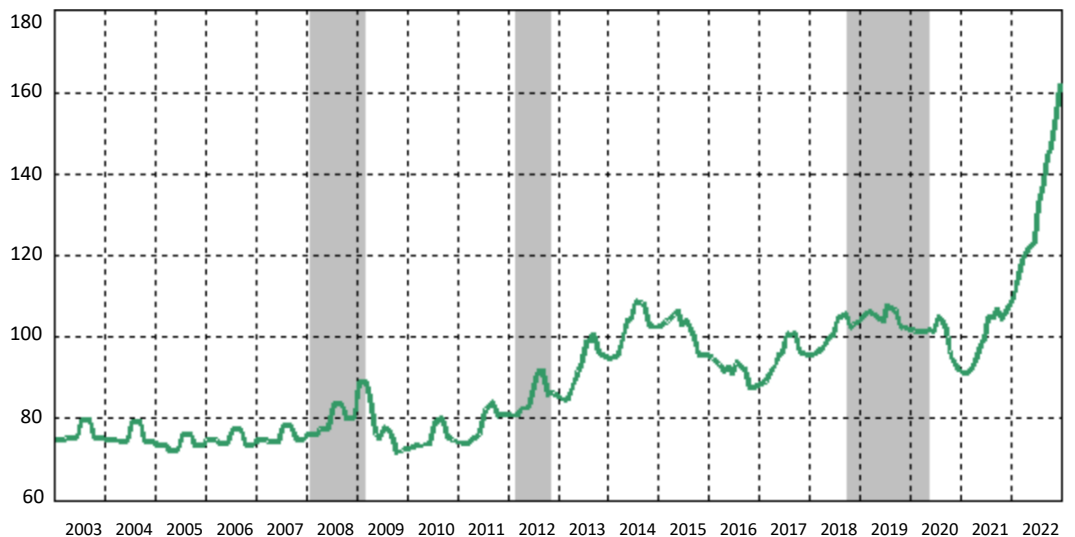

Source: compiled by SIR from BOJ CGPI Index time-series database (CY2020 = 100). Recession periods indicated in grey.

LEGAL DISCLAIMER

This report is intended to provide information about the subject company, and it is not intended to solicit or recommend investment. Although the data and information contained in this report have been determined to be reliable, we do not guarantee their authenticity or accuracy.

This report has been prepared by Sessa Partners on behalf of the concerned company for which it has received compensation. Officers and employees of Sessa Partners may be engaged in transactions such as trading in securities issued by the company, or they may have the possibility of doing so in the future. For this reason, the forecasts and information contained in this report may lack objectivity. Sessa Partners assumes no liability for any commercial loss based on use of this report. The copyright of this report belongs to Sessa Partners. Modification, manipulation, distribution or transmission of this report constitutes copyright infringement and is strictly prohibited.



Sessa Partners Inc.

#5a i-o Azabu, 2-8-14
Azabujyuban, Minato-ku, Tokyo
info@sessapartners.co.jp